

Visita de Mercado ao Brasil, Olimpíadas 2016, Rio De Janeiro/São Paulo, Março 2010

- Especialistas do Reino Unido –
Ancoragem & Fixações

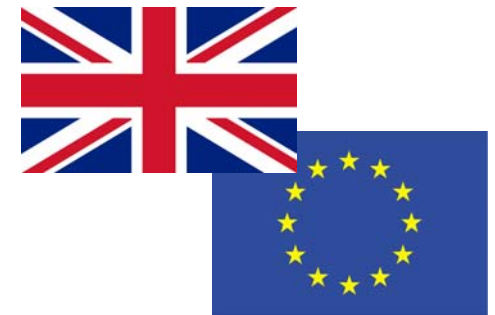

03. – 26.03.2010



Construction Products Solutions Ltd.

- Fundada em 2006
- Para desenvolver e produzir novas e existentes fixações e âncoras
- Patenteada e produzindo novas fixações de isolamento de telhado plano com sucesso
- Localizada em Bishops Stortford, próximo do aeroporto de Stansted /

CPS International Ltd.

- Exportações para EUA, Canadá, Ásia, Europa, Oriente Médio e Austrália
- BS EN ISO 9001:2000
- Fusão no final de 2009 com Brütt Industrie Holding GmbH para formar:
Constructions Products Solutions International Ltd.
(CPSI)



Serviços & Apoio

- Teste de ancoragem e recomendações de adequação de produtos
- Cooperação com centros de excelência



Serviços & Apoio

- Registro ISO
- Soluções de Produto Especial / Sob Medida
- Aprovações



Certificate of Registration

This document certifies that the quality management systems of
CONSTRUCTION PRODUCT SOLUTIONS LTD

Have been assessed and approved by CQS
(Certified Quality Systems) Limited
to the following quality management
systems, standards and guidelines :

BS EN ISO 9001:2000

The scope of this certification applies to the approved
quality management systems relating to the following activities:

SALES OF SPECIALIST CONSTRUCTION PRODUCTS

Certificate issued 21st February 2006

Certificate number GB2001835

Should verification of the validity of this certificate
be required please contact:
CQS (Certified Quality Systems) Ltd
London Kingsway House Q21111 +44(0)2084 281248
email: certification@cpqsltd.co.uk



On behalf of CQS Certified Quality Systems Limited

This Certificate remains valid only while the holder maintains their quality management systems in accordance with the guidelines above.
This Certificate remains the property of CQS (Certified Quality Systems) Limited and must be returned in the event of cancellation.

5113

EAC 28

Mercados

- Construção Geral e Engenharia Civil
- Chapeados/ Fachadas e Paredes Estruturais Exteriores
- Mecânica, Elétrica, Aquecimento e Ventilação
- Reformas, Reparos de Alvenaria, e Isolamentos



Produtos

- Surefit
 - Âncora Universal:
 - Concreto
 - Alvenaria sólida
 - Ligação de armações metálicas, aço, alumínio e madeira
 - Prevenção de ferrugem em piscinas



Produtos

- SureUC
 - Chumbadores de segurança para:
 - Pedra
 - Cerâmica
 - Vidro
 - HPL
 - Construção de revestimento tela de chuva / fachada cortina

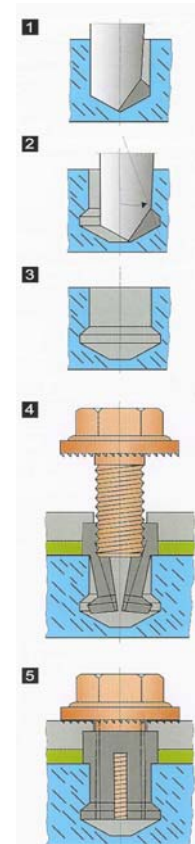

Produtos

- SureLoc
 - Fixação de múltiplos usos:
 - Concreto
 - Alvenaria sólida
 - Fixação de todos os tipos de garras de canos & cabos, Equipamento M&E



Produtos

- SureHit
 - KDM Ancoragem:
 - Concreto
 - Fixação de todos os materiais de proteção anti-incêndio, o canal, as condutas, os sistemas de aspersão e tetos falsos

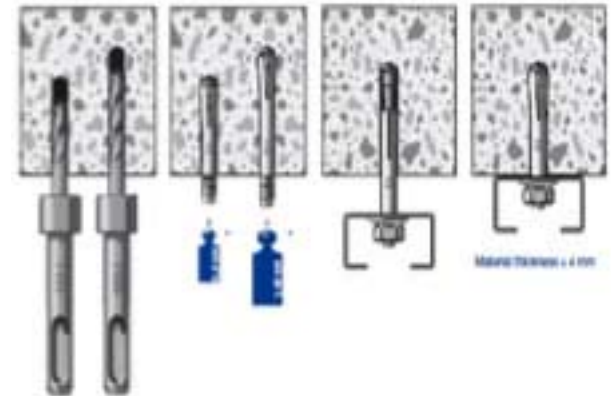

Produtos – SureHit

- K ancoragem para cargas pesadas:
 - Lajes de piso de concreto oco
 - Fixação de todos os tipos de trabalhos em metal
- T ancoragem para cargas leves para:
 - Lajes de piso de concreto oco
 - Fixação de tetos suspensos

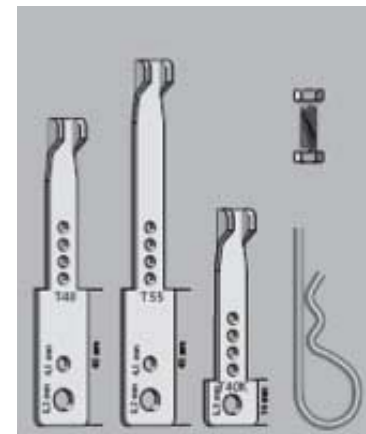

Produtos – SureHit

- Fixadores de cabos de rádio para túnel

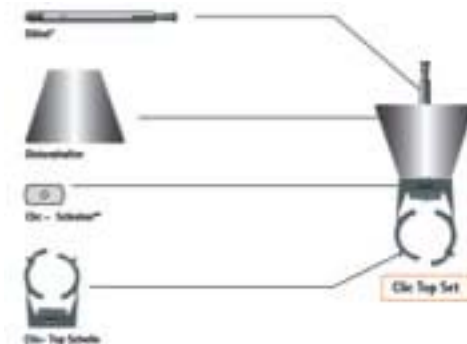

Produtos – SureHit

- Ancoragem AC para cargas pesadas para:
 - Concreto poroso
 - Fixação de todos tipos de materiais, trabalhos em metal, equipamentos, madeira e esquadrias

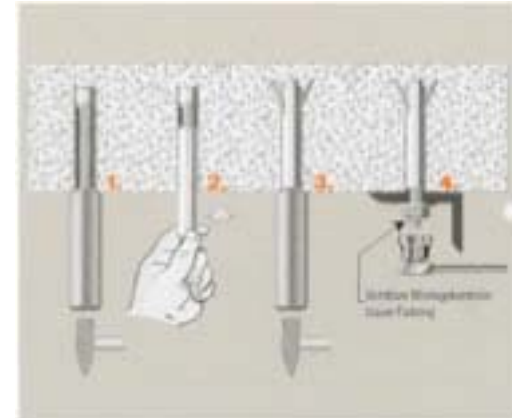

Produtos – AirTwist

- Ancoragem AirTwist de carga leve para:
 - Concreto poroso
 - Fixação de todos os tipos de materiais de madeira

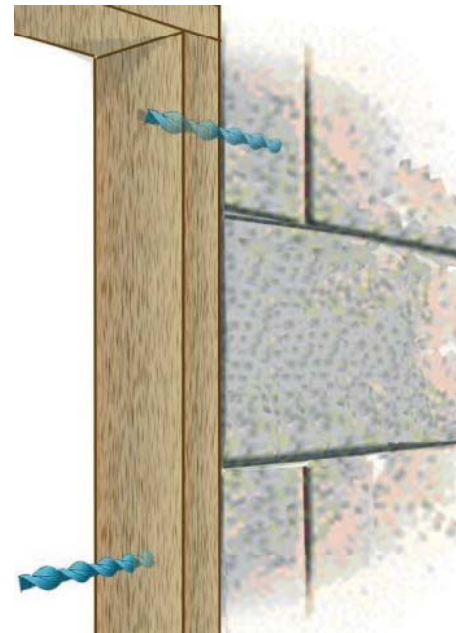

Produtos – SureTwist

- Gama completa de ancoragem helicoidal de fixação e reparo para muitos materiais de base, incluindo madeira, assim como alvenaria, prédios novos e antigos
- Costura de rachaduras e sistemas de reparo adequado para todos os tipos de alvenaria



Produtos – SureTwist

- Fixação de teto aquecido para inserção de madeira / conexões de madeira
- BigTwist fixação de isolantes ligação de isolantes em telhados planos

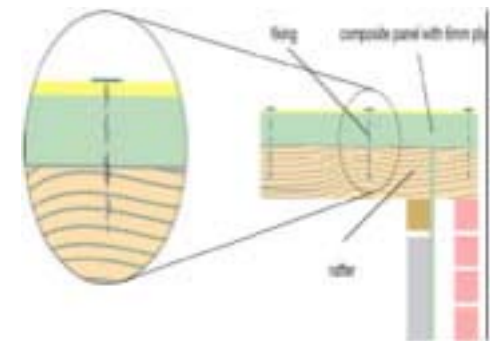
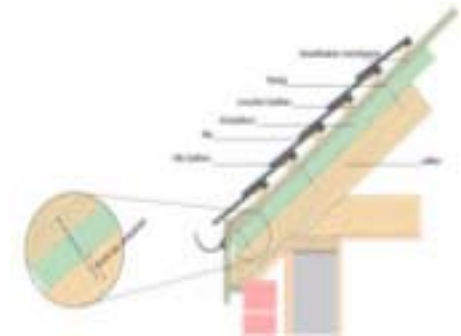

SURETWIST
BIGTWIST

Produtos – SureClamp

- Maneira segura de manter o canal no lugar enquanto o concreto está sendo derramado



SureUC

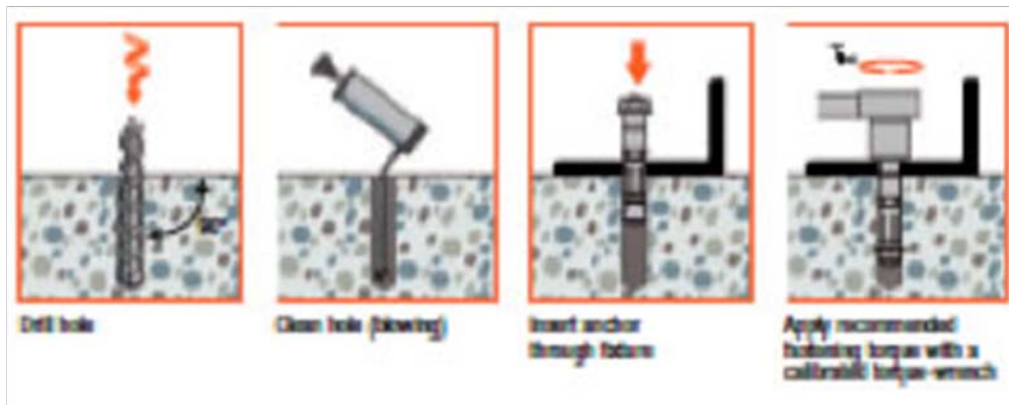
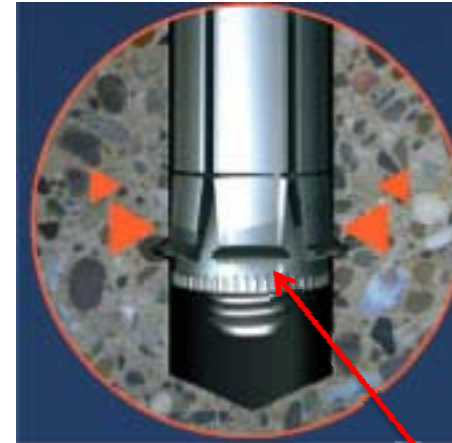

Âncora de expansão – SureBolt



Produtos – Produtos diversos

- SureReel
 - Melhora a saúde & segurança com um dispositivo para instalar fio de amarração de reforço
- Surebond
- Impede infiltração de humidade na alvenaria



Produtos – Produtos diversos

- SureFlange
 - Flanges duplex de aço inox, tubulação / acessórios para tubos, conexões, parafusos para as indústrias de petróleo, gás, química e alimentícia



Produtos – Produtos diversos

- SureBond
 - uma vasta gama de materiais resinosos para ancoragem e reparos



Projetos – Fixação de assento de estádio

- Ancoragem: Surefit SF 12/10 P
- 12mm Ø, Parafuso Ø = 12,00mm
- Aço galvanizado e passivado 8,8 H.T
- Furo em concreto = 12,00mm Ø
- *Furo/ranhura no suporte \geq 12,50mm Ø*

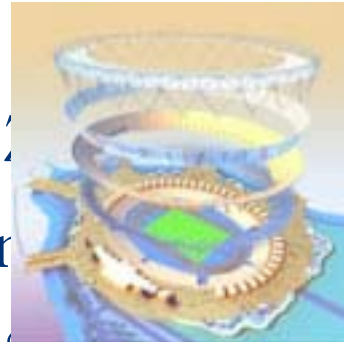

Projetos – Assento de estádios

- Espessura da fixação = 0 – 10,00mm
- Profundidade do buraco = 70,00mm
- Torque de instalação = 15Nm
- Chave A/F = 10
- Nota: Arruela adicional de 19mm Ø para acomodar a caneleta de suporte

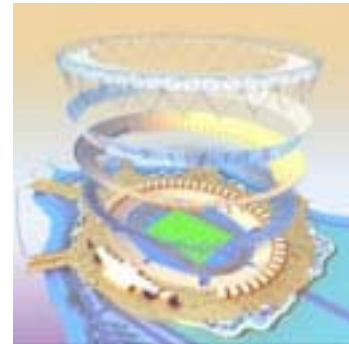

Projetos – Assento de estádio

- Teste de instalação do suporte



Projetos – Assento de estádio

- Teste de instalação do suporte



Projetos – Assento de estádio

- Teste de instalação do suporte
 - 1.000 Kg antes da falha
 - Distância da extremidade = 20.000mm!!!



Projetos – Assento de estádios

- Teste de instalação do suporte
 - 1.000 Kg antes da falha
 - Distância da extremidade = 20.000mm



Projetos – Assento de estádios

- Teste de instalação do suporte



Projetos – Assento de estádio



- Resolução de problemas adicionais...

- Fixação de prancha oca
- Fixação através do isolamento

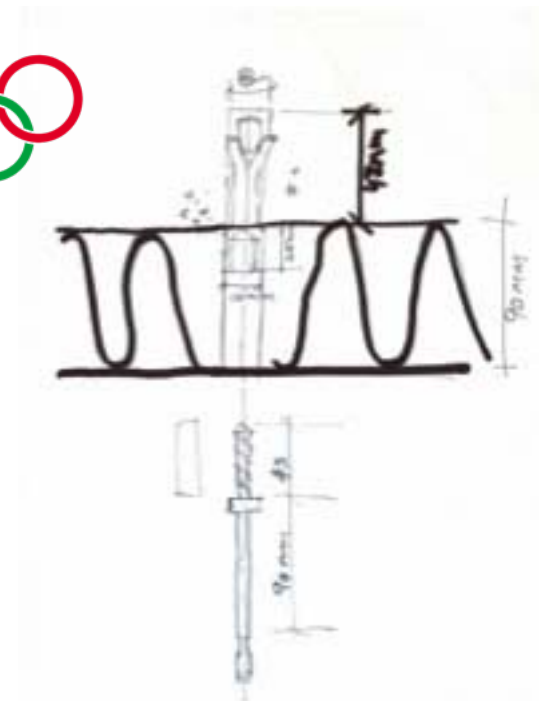

Projetos – Assento de estádio

- Resolução de problemas adicionais...

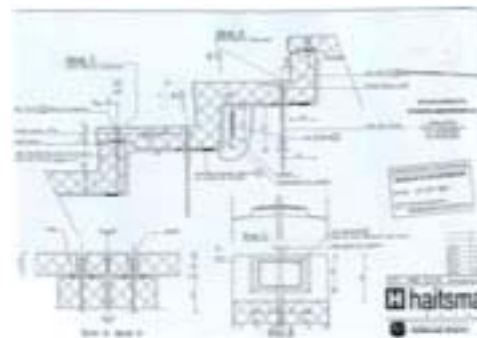
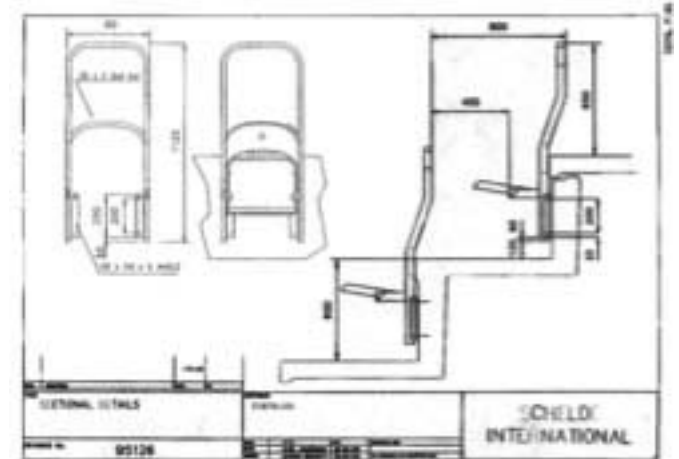
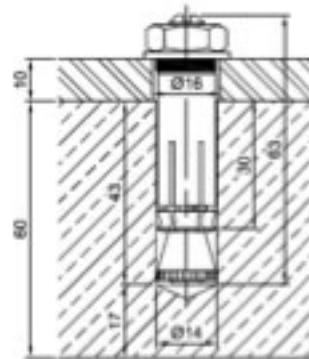
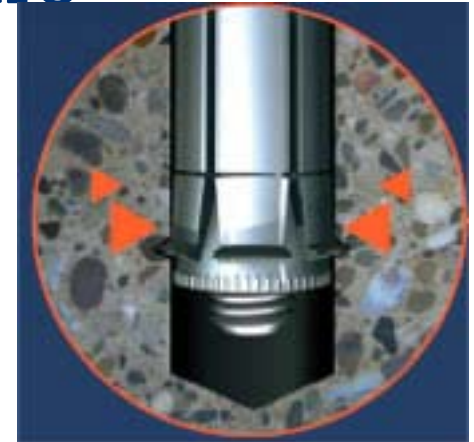

Projetos – Liverpool

- Man Island –
Desenvolvimento comercial

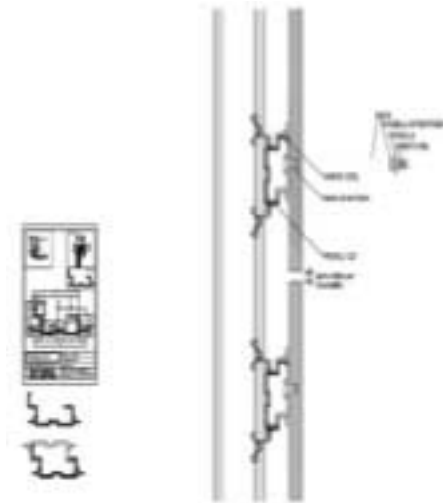
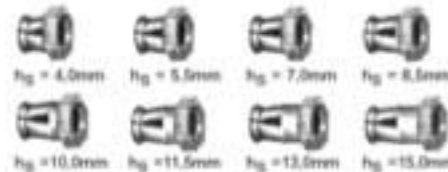
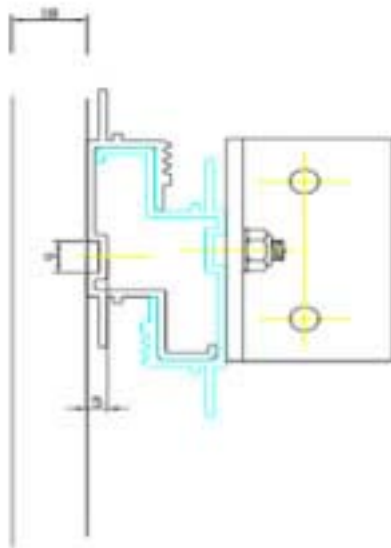

Projetos – Liverpool

- Man Island –
Granito preto, 18mm de
espessura, reforçado



Projetos – Liverpool

- Man Island –
58,000 âncoras



Projetos

- Jamnagar, Índia.
- Nova planta petroquímica de multi milhões de dólares da Reliance Oil Industries.
- Mais de 100.000 operários
- Mais de 250.000 âncoras resistentes a

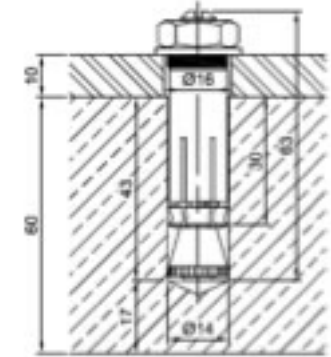

Projetos – Prédio Financeiro

- Xangai / China

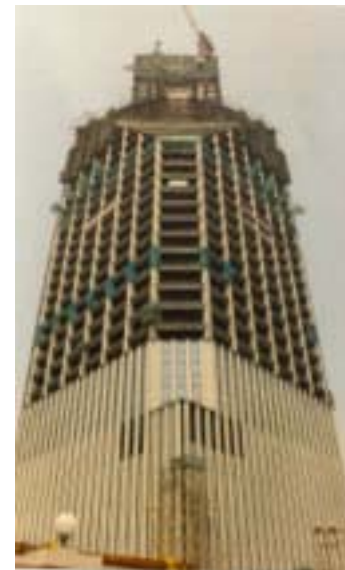
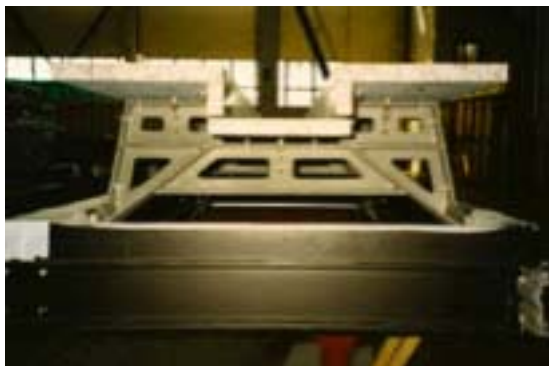

Projetos – Qing Mao, Xangai

- China

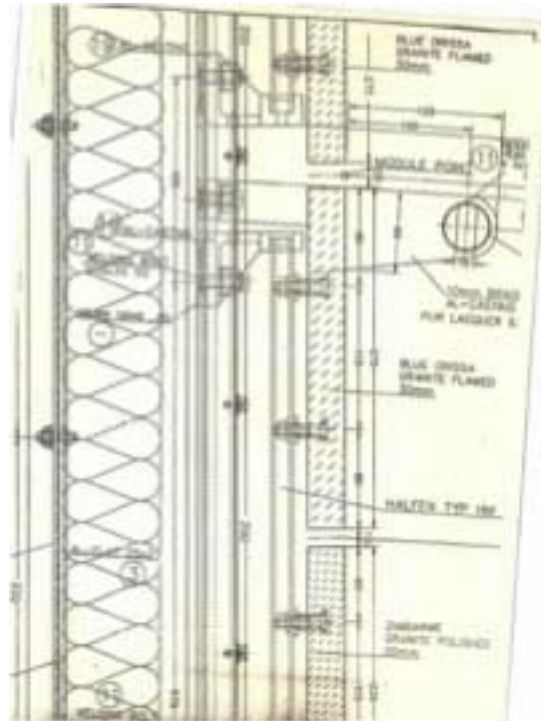

SureUC

- Âncora rebaixada para vidro. Inserção usando suporte de tela de chuva de alumínio e componentes

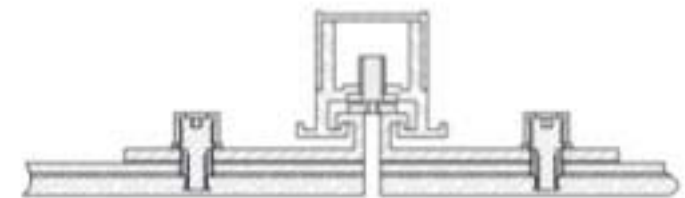
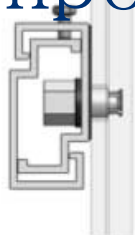
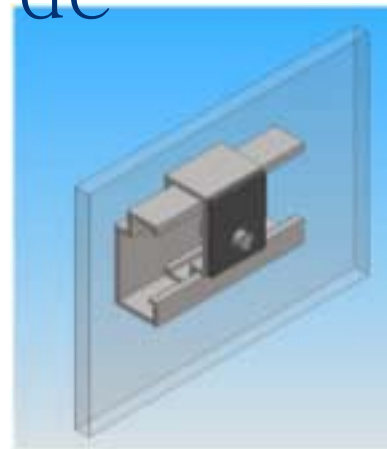

Projetos

- Construção de cubo de vidro usando somente estrutura de aço ligada nas âncoras rebaixadas fixadas no vidro



Projetos – SureBolt

- Drax Power Station, Nordeste da Inglaterra
- Chaminé, estrutura de concreto mais alta na europa
- Remodelada com novo revestimento de titânio, fixada com âncora de titânio

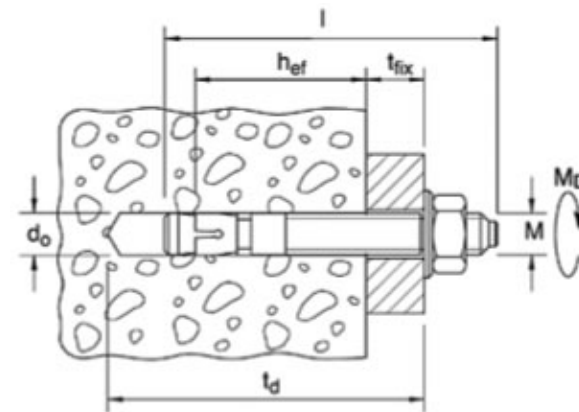

Projetos

Intenção Arquitetural

+

Aspirações dos empreiteiros

=

Satisfação do Cliente

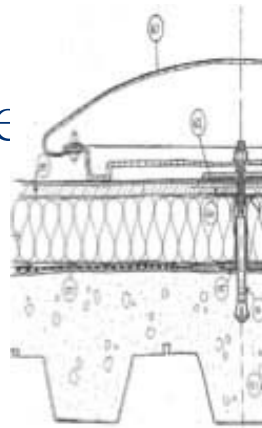

Projetos – Elb Tunnel – em Hamburgo

- Âncoras de aço inoxidável especial de alta qualidade [DIN1.4529] para a fixação da placa anti-incêndio e tetos suspensos em cada tubo



Obrigado pelo seu interesse e
esperamos poder auxiliar no futuro

